

Edge of Arlington Saw & Tool, Inc.

124 South Collins
Arlington, TX 76010
Phone: 817-461-7171 • Fax: 817-795-6651
Toll Free: 888-461-7171
Email: info@eoasaw.com
Website: www.eoasaw.com

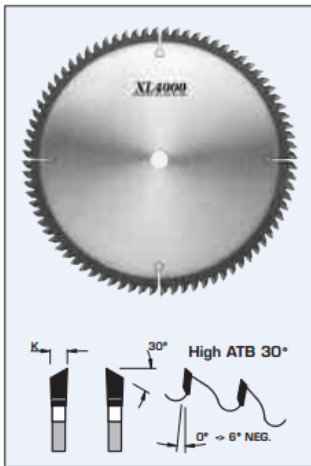

Item #SM6401, FS Tool XL4000 Extended Life Chip-Free Melamine Trim Blades

\$429.04

Thank you for shopping with us!

Design:

- Tooth configuration: High ATB 30 deg
- Cutting Material: TC XL4000
- Expansion slots: Cu Plugged

Application:

- For chip-free sizing cuts (on both sides) in melamine and wood veneered panels, without the need for prescoring
- For fine crosscutting in solid woods
- On table saws, sliding table saws, vertical panel sizing saws, and cut-off saws

SPECIFICATIONS

Manufacturer	FS Tool
Diameter	16 in
Bore	1 in
Kerf	.157 in
Machine	--
Plate	0.118 in
Teeth	120