

Edge of Arlington Saw & Tool, Inc.

124 South Collins
Arlington, TX 76010
Phone: 817-461-7171 • Fax: 817-795-6651
Toll Free: 888-461-7171
Email: info@eoasaw.com
Website: www.eoasaw.com

Item #RB-111, Amana Tool High Precision 1/2 x 4mm Router Collet Reducer

\$13.09

Thank you for shopping with us!

Our industrial high precision machined collet reduction sleeves enable collet sizes to be reduced to accept CNC and router bits with smaller shank sizes. Reduction sleeves are produced with high quality steel and precisely machined to limit the chance of run-out.

Warning: Reducing the router collet with a sleeve is not a long term solution; for best results using the correct size collet is strongly recommended.

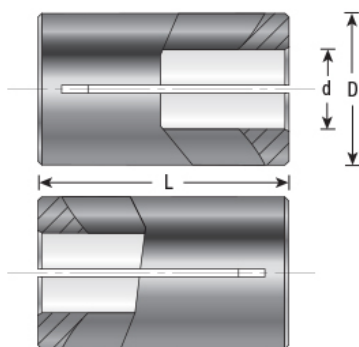

SPECIFICATIONS

Manufacturer	Amana Tool
Diameter	1/2 in
Overall Length	1 in
Shank	4 mm