

Edge of Arlington Saw & Tool, Inc.

124 South Collins
Arlington, TX 76010
Phone: 817-461-7171 • Fax: 817-795-6651
Toll Free: 888-461-7171
Email: info@eoasaw.com
Website: www.eoasaw.com

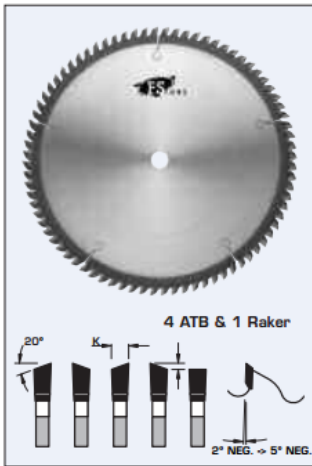

Item #LH182, FS Tool Professional Line Mitre Joint Saw Blades

\$138.16

Thank you for shopping with us! **Design:**

- Tooth configuration: 4 ATB & 1 Raker
- Cutting Material: TC
- Expansion slots: laser, self plug

Application:

- For mitre joint cuts in soft and hardwood picture frames and furniture mouldings
- On cut-off mitre machines, compound mitre machines, radial arm saws, and table saws

SPECIFICATIONS

Diameter	10 in
Bore	5/8 in
Kerf	.110 in
Machine	--
Plate	.080 in
Teeth	80
Manufacturer	FS Tool