

## Edge of Arlington Saw & Tool, Inc.

124 South Collins  
Arlington, TX 76010  
Phone: 817-461-7171 • Fax: 817-795-6651  
Toll Free: 888-461-7171  
Email: [info@eoasaw.com](mailto:info@eoasaw.com)  
Website: [www.eoasaw.com](http://www.eoasaw.com)

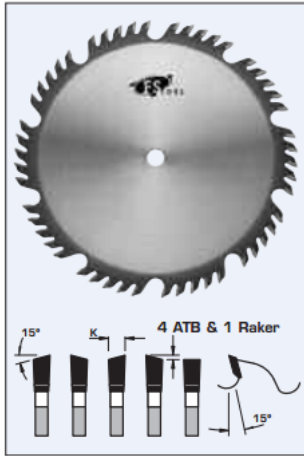

### Item #L55400, FS Tool Industrial Quality Combination Saw Blades

**\$274.76**

Thank you for shopping with us!

#### Design:

- Tooth configuration: 4 ATB & 1 Raker
- Cutting Material: TC
- Four ATB teeth and one raker with a deep gullet allows deeper cuts and improved chip flow

#### Application:

- For crosscutting and ripping dry soft and hardwoods, plywood, and particleboard.
- On table saws, sliding table saws, and cut-off saws

## SPECIFICATIONS

<b>Diameter</b>	16 in
<b>Bore</b>	1 in
<b>Kerf</b>	.165 in
<b>Manufacturer</b>	FS Tool
<b>Plate</b>	.118 in
<b>Teeth</b>	80