

## Edge of Arlington Saw & Tool, Inc.

124 South Collins  
Arlington, TX 76010  
Phone:817-461-7171 • Fax: 817-795-6651  
Toll Free: 888-461-7171  
Email: [info@eoasaw.com](mailto:info@eoasaw.com)  
Website: [www.eoasaw.com](http://www.eoasaw.com)

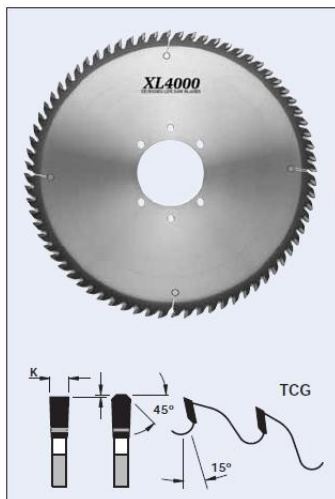

### Item #L5238060-60, FS Tool XL4000 Extended Life Panel Sizing Saw Blades: TCG **\$303.24**

Thank you for shopping with us!

XL4000: 20 years of development has refined every aspect of our saw blade manufacturing, materials, and geometries. We offer nearly 1500 models all derived from the same engineering resources compiled over three decades of application experience. From plate to finished saw blade, each is manufactured using the latest technology. Once the plate has been transformed into the most formidable TCT saw blade on the market, it undergoes a nearly artisan, manual tensioning process. Renowned as the premier saw blade available throughout our industry, the XL4000 series will provide measurable cost savings by reducing machine downtime and by increasing your production's efficiency and quality of cut.

#### **Design:**

- Tooth configuration: TCG
- Carbide Grade: **TC XL4000**
- Expansion slots: Cu plugged

#### **Application:**

- For sizing cuts in plastic laminated panels and plywood in single sheets and stacks
- On panel sizing saws (Beam Saws)

## SPECIFICATIONS

<b>Manufacturer</b>	FS Tool
<b>Diameter</b>	380 mm
<b>Bore</b>	60 mm
<b>Grind</b>	TCG
<b>Kerf</b>	4.4 mm
<b>Machine</b>	Holzma
<b>Plate</b>	3.2 mm
<b>Teeth</b>	60
<b>Note</b>	CU Plugged Expansion Slots