

Edge of Arlington Saw & Tool, Inc.

124 South Collins
Arlington, TX 76010
Phone:817-461-7171 • Fax: 817-795-6651
Toll Free: 888-461-7171
Email: info@eoasaw.com
Website: www.eoasaw.com

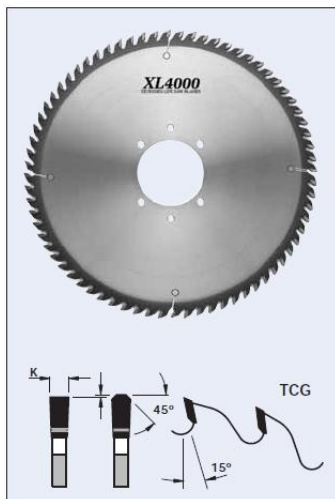

Item #L5250860-60, FS Tool XL4000 Extended Life Panel Sizing Saw Blades: TCG **\$434.36**

Thank you for shopping with us!

XL4000: 20 years of development has refined every aspect of our saw blade manufacturing, materials, and geometries. We offer nearly 1500 models all derived from the same engineering resources compiled over three decades of application experience. From plate to finished saw blade, each is manufactured using the latest technology. Once the plate has been transformed into the most formidable TCT saw blade on the market, it undergoes a nearly artisan, manual tensioning process. Renowned as the premier saw blade available throughout our industry, the XL4000 series will provide measurable cost savings by reducing machine downtime and by increasing your production's efficiency and quality of cut.

Design:

- Tooth configuration: TCG
- Carbide Grade: **TC XL4000**
- Expansion slots: Cu plugged

Application:

- For sizing cuts in plastic laminated panels and plywood in single sheets and stacks
- On panel sizing saws (Beam Saws)

SPECIFICATIONS

Manufacturer	FS Tool
Diameter	500 mm
Bore	60 mm
Grind	TCG
Kerf	4.8 mm
Machine	Holzma
Plate	3.5 mm
Teeth	60
Note	CU Plugged Expansion Slots