

Edge of Arlington Saw & Tool, Inc.

124 South Collins
Arlington, TX 76010
Phone: 817-461-7171 • Fax: 817-795-6651
Toll Free: 888-461-7171
Email: info@eoasaw.com
Website: www.eoasaw.com



Item #HO-220, Amana Tool CAT 40 High Precision ER Collet 50mm Chuck Tool Holders (Industrial) \$118.58

Thank you for shopping with us!

Amana Tool CAT 40 High Precision ER Collet 35mm Chuck Tool Holders

- Made from alloy steel hardened to 54 - 56rc
- Tool Holders Balanced to G2.5 at 25 000 RPMs
- Coolant thru capability
- Concentricity is less than .0002 at collet face
- Rear thread for pull stud is 5/8 - 11
- Spring collet not included

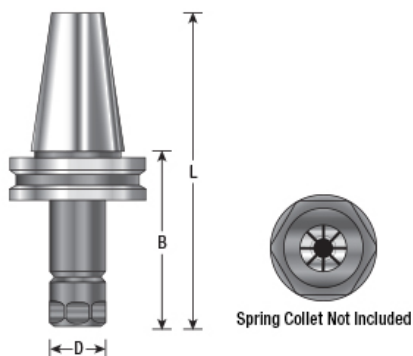

SPECIFICATIONS

Manufacturer	Amana Tool
Cut Height, Length, or Width	4 in
Length	203.4 mm
Style	CAT 40
Thread Size/Length	5/8-11 in
Type	Collet ER32