

Edge of Arlington Saw & Tool, Inc.

124 South Collins
Arlington, TX 76010
Phone: 817-461-7171 • Fax: 817-795-6651
Toll Free: 888-461-7171
Email: info@eoasaw.com
Website: www.eoasaw.com



Item #FO-206, Amana Tool High Carbon Tool Steel Forstner Pattern Bit 13/16 Dia x 3/8 Shank \$16.38

Thank you for shopping with us!

Application: Drill pocket holes, flat-bottom holes (note: a small pilot hole used for centering will be present on flat bottom holes), etc., using any 3/8" or larger portable drill or stationary drill press. Forstner pattern bits are well-known for their ability to drill clean and chip-free holes in wood. Amana Tool® uses only the finest quality tool steel, precision machined and ground on state-of-the-art equipment. Large gullets milled in the tool body provide exceptional chip clearance.

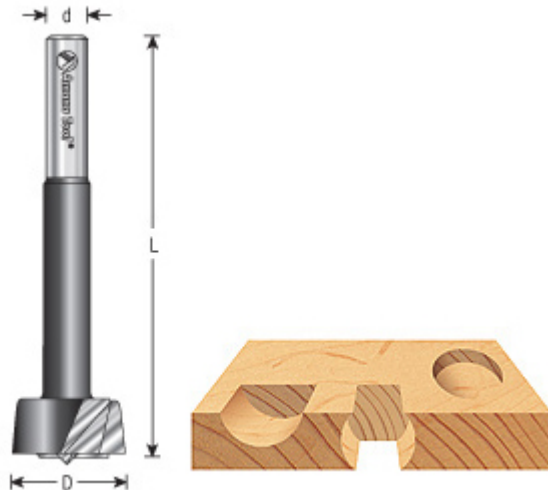

SPECIFICATIONS

Manufacturer	Amana Tool
Diameter	13/16 in
Note	A small pilot hole used for centering will be present on flat bottom holes
Overall Length	3 1/2 in
Shank	3/8 in