

Edge of Arlington Saw & Tool, Inc.

124 South Collins
Arlington, TX 76010
Phone: 817-461-7171 • Fax: 817-795-6651
Toll Free: 888-461-7171
Email: info@eoasaw.com
Website: www.eoasaw.com



Item #CD008, Freud Calibration & Sanding Disks

\$37.17

Thank you for shopping with us!

Application: For Sanding & Accurately Aligning Your Saw for Optimal Performance

These calibration and sanding disks are a real time saver for aligning a saw. They are precision ground extra thick for absolute balance and flatness. Simply mount the disk onto the saw and align the disk with a square. Because there are no teeth in the way, it will produce a more accurate reading. Then simply remove the disk and mount your blade. Freud Disks will also turn your table saw into a disk sander. Simply mount any of the adhesive backed Freud Sanding Disks (4 popular grits available) onto the Freud Calibration and Sanding Disk and use as a disk sander. These disks will save you time and money.

Use on any table saw, radial arm saw, or miter saw.

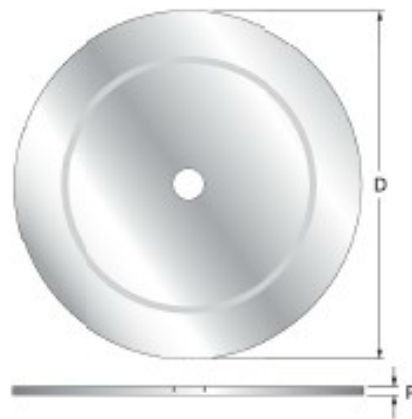

SPECIFICATIONS

Manufacturer	Freud Tools
Diameter	8 in
Bore	5/8 in
Plate	1/8 in