

## Edge of Arlington Saw & Tool, Inc.

124 South Collins  
Arlington, TX 76010  
Phone: 817-461-7171 • Fax: 817-795-6651  
Toll Free: 888-461-7171  
Email: [info@eoasaw.com](mailto:info@eoasaw.com)  
Website: [www.eoasaw.com](http://www.eoasaw.com)



### Item #85-165, Freud Round Over Bowl Bits \$119.84

Thank you for shopping with us!

**Application:** Trims joint between solid surface countertops and solid surface sink bowls with a smooth, rounded edge

- Specially formulated carbide is ideal for fabricating solid surface materials
- Features non-marring synthetic bearing to protect finished edges
- Cuts all solid surface materials
- Use in hand-held portable routers

85-140

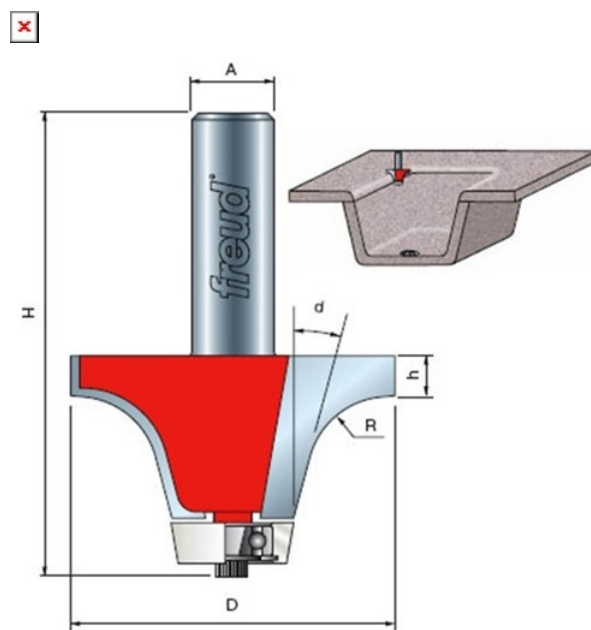

## SPECIFICATIONS

<b>Manufacturer</b>	Freud Tools
<b>Angle</b>	10 deg
<b>Cut Height, Length, or Width</b>	1 1/4 in
<b>Overall Length</b>	3 1/8 in
<b>Radius</b>	3/4 in
<b>Shank</b>	1/2 in

## SPECIFICATIONS

<b>Type</b>	For Avonite, Corian, Fountainhead, Formica bowls. Transolid & Hi-Macs sinks
<b>Usage/System</b>	For Top Thickness 3/4 in