

Edge of Arlington Saw & Tool, Inc.

124 South Collins
Arlington, TX 76010
Phone: 817-461-7171 • Fax: 817-795-6651
Toll Free: 888-461-7171
Email: info@eoasaw.com
Website: www.eoasaw.com

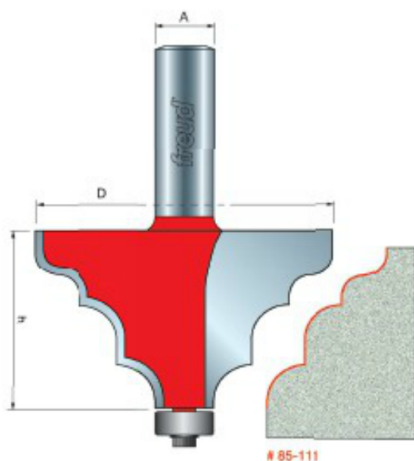

Item #85-111, Freud Solid Surface Edge Profile Bits \$151.92

Thank you for shopping with us!

Application: Decorative Edges on all solid surface tops

- Specially formulated carbide is ideal for fabricating solid surface materials
- Cuts all solid surface materials
- Use in hand-held portable routers.

SPECIFICATIONS

Manufacturer	Freud Tools
Diameter	2 1/2 in
Bearing(s)	Steel Bearing
Cut Height, Length, or Width	1 1/2 in
Shank	1/2 in