

Edge of Arlington Saw & Tool, Inc.

124 South Collins
 Arlington, TX 76010
 Phone:817-461-7171 • Fax: 817-795-6651
 Toll Free: 888-461-7171
 Email: info@eoasaw.com
 Website: www.eoasaw.com



Item #8045 Kit, Vortex Series 8000 HSK63F 4" Integrated Spoilboard Cutter -8045 BODY W/ 13273 INSERT
\$970.44

Thank you for shopping with us! Vortex is now offering our spoilboard cutters with our newly developed "integrated" tool design. This series is a solid, one-piece unit with the HSK63F taper "built in" to the tool. The one-piece design affords superior performance and years of worry-free use, which over time will greatly reduce wear and tear on your machine spindle.

8045-KIT

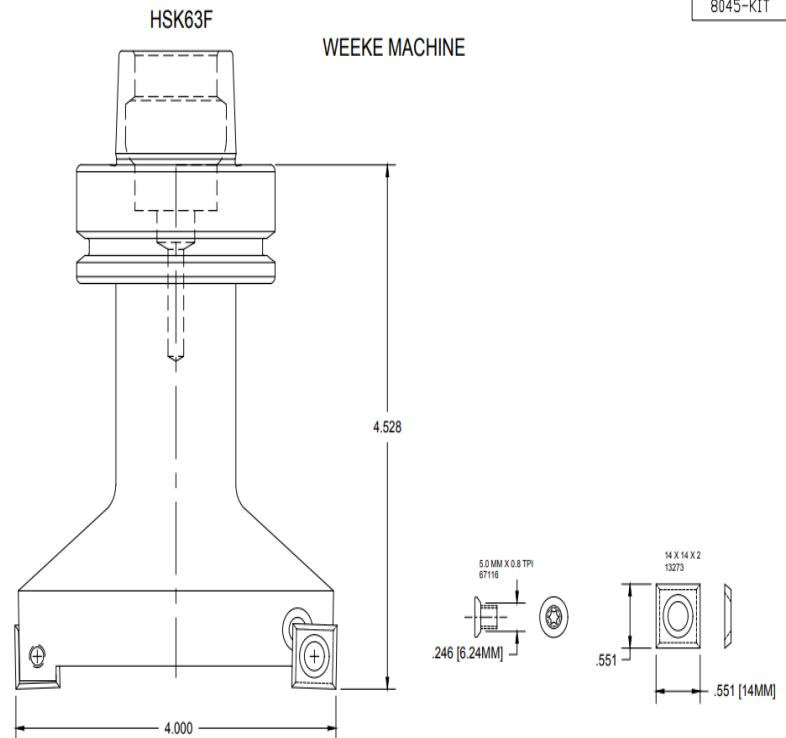

SPECIFICATIONS

Diameter	4 in
Cut Depth	1/2 in
Includes	8045 - 4 in Spoilboard Cutter, 67116 Screws, 13273 Inserts, 7001W Wrench
Taper	HSK63F
Wings	3
Overall Length	4 in

SPECIFICATIONS

Manufacturer Vortex Tool