

Edge of Arlington Saw & Tool, Inc.

124 South Collins
Arlington, TX 76010
Phone: 817-461-7171 • Fax: 817-795-6651
Toll Free: 888-461-7171
Email: info@eoasaw.com
Website: www.eoasaw.com



Item #57311, Amana Tool Plastic Cutting Metric CNC Spiral O Flute Mirror Finish 2mm x 8mm x 6mm Shank Upcut Solid Carbide Router Bit **\$46.65**

Thank you for shopping with us!

Produce super-clean smooth cuts, especially in acrylic materials (Plexiglas®, Lucite®), other plastics, and wood. Bits are made according to strict tolerances from an exclusive carbide grade and polished to a mirror finish using Amana's unique process. Designed for industrial applications and CNC machines.

Excellent for cutting: plastic/acrylic, acrylonitrile butadiene styrene (ABS), alupanel®, acetal & nylon, corrugated polypropylene, delrin, gator board, foam board, high density polyethylene (HDPE), Lucite®, mechanical/engineered plastics, Plexiglas®, polycarbonates, solid surface, ultra high molecular weight polyethylene (UHMW), and wood.

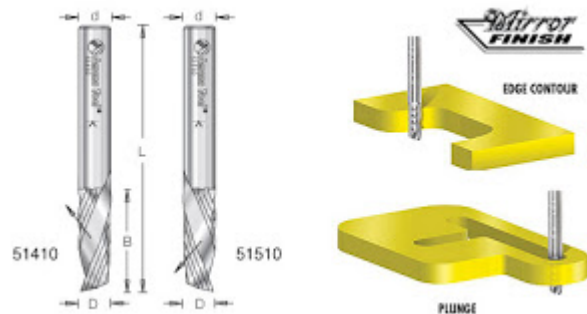

Benefits of Mirror Finish:
Razor-sharp cutting edge. Effortless chip removal.
Exceptional cut quality. Helps prevent chip re-welding.
Extends tool life.

SPECIFICATIONS

Manufacturer	Amana Tool
Diameter	2 mm
Cut Height, Length, or Width	8 mm

SPECIFICATIONS

Flute Geometry	Upcut
Flute	1 'O' Flute
Overall Length	64 mm
Shank	6 mm