

Edge of Arlington Saw & Tool, Inc.

124 South Collins
Arlington, TX 76010
Phone: 817-461-7171 • Fax: 817-795-6651
Toll Free: 888-461-7171
Email: info@eoasaw.com
Website: www.eoasaw.com

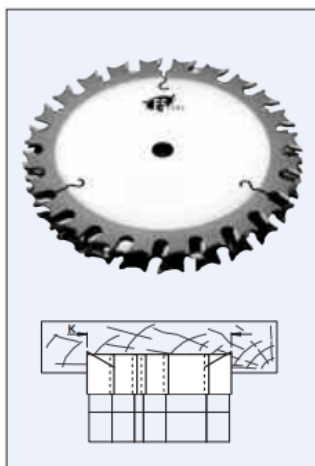

Item #5308-14S, FS Tool Industrial Quality Safety Dado Sets & Anti-Kickback; Design: Spare Chippers 2-Teeth **\$56.80**

Thank you for shopping with us!

Design:

- Standard set consists of two outside saw blades 1/8" kerf, one 1/4" chipper, two 1/8" chippers, and one 1/16" chipper
- "Anti-Kickback" design reduces the risk of kick-back
- Cutting Material: TC

Application:

- To cut grooves and dados in soft and hardwoods, plywood, and veneered panels
- Groove widths adjustable from 1/4" to 13/16" maximum width in 1/16" increments. Wider grooves can be obtained by adding spare chippers
- On table saws, sliding table saws, and single- or double-end tenoners

SPECIFICATIONS

Diameter	8 in
Bore	5/8 in
Kerf	1/4 in
Manufacturer	FS Tool