

Edge of Arlington Saw & Tool, Inc.

124 South Collins
Arlington, TX 76010
Phone:817-461-7171 • Fax: 817-795-6651
Toll Free: 888-461-7171
Email: info@eoasaw.com
Website: www.eoasaw.com



Item #518108, Amana Tool Carbide-Tipped Aluminum & Non-Ferrous Metals 18 Inch Dia x 108T TCG, -6 Deg, 1" Bore - For Thick Aluminum **\$213.60**

Thank you for shopping with us!
For Thick Aluminum (over 0.25")

Ideal for cutting aluminum and non-ferrous metal bars such as copper, brass, bronze, and lead. It is also good for cutting extrusions and profiles. The negative hook angle (-6°), triple-chip grind, and thick plate combine to produce a superior finish. The blade can also be used to cut other "difficult" materials such as plastic, PVC tubing, fiberglass, and ACM such as Alucobond®, Dibond®, and Durabond. Use a coolant or blade wax and clamp down the workpiece when cutting non-ferrous metals.

Warning: Never attempt to cut ferrous metals (steel, iron, etc.) with these saw blades!

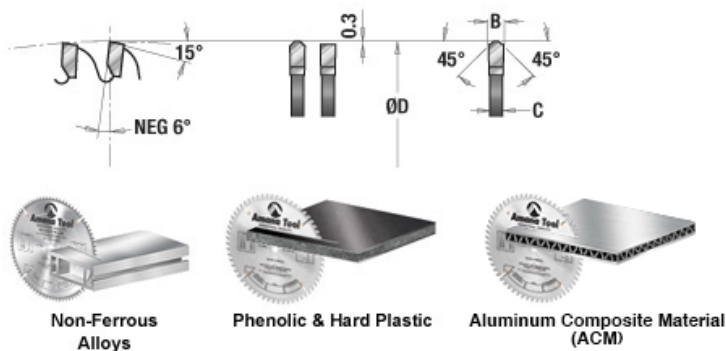

SPECIFICATIONS

Manufacturer	Amana Tool
Bore	1 in
Diameter	18 in (450 mm)
Grind	TCG
Hook Angle	6 deg negative hook
Kerf	0.157

SPECIFICATIONS

Pinholes	--
Plate	.134 in
Teeth	108
Material	For Thick Aluminum (over 0.25 in)