

Edge of Arlington Saw & Tool, Inc.

124 South Collins
Arlington, TX 76010
Phone: 817-461-7171 • Fax: 817-795-6651
Toll Free: 888-461-7171
Email: info@eoasaw.com
Website: www.eoasaw.com



Item #51323, Amana Tool Stagger Tooth Plunge Cutting Carbide-Tipped 1/2" x 2 5/8" x 1/2" Shank Router Bit: 2-Blade Stagger \$47.63

Thank you for shopping with us!

Two cutting edges spaced 180 degrees apart, each half the length of its flute. One extends from the tip to the middle of the flute, the other from the middle to end. The configuration combines the cutting speed and chip clearance of a single-flute bit with the finish of a double-flute bit. Excellent bit for cutting dense or abrasive man-made materials and panel goods.

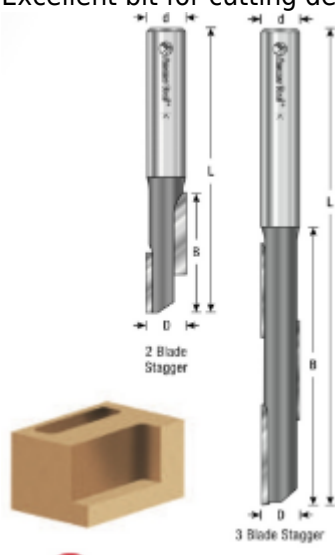

SPECIFICATIONS

Manufacturer	Amana Tool
Diameter	1/2 in
Cut Height, Length, or Width	2 5/8 in
Overall Length	5 1/2 in
Shank	1/2 in
Type	2-Blade Stagger