

Edge of Arlington Saw & Tool, Inc.

124 South Collins
Arlington, TX 76010
Phone: 817-461-7171 • Fax: 817-795-6651
Toll Free: 888-461-7171
Email: info@eoasaw.com
Website: www.eoasaw.com

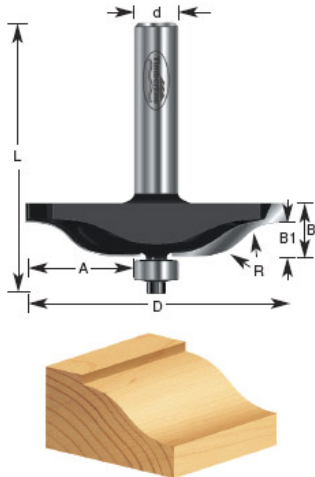

Item #420-22, Amana Professional Quality Raised Panel Router Bits - Ogee

\$76.16

Thank you for shopping with us! Build quality ogee raised panels for your cabinet doors. 1/2" Shank 2 Flute with ball bearing guide Professional Quality Carbide-Tipped Use in a table-mounted router. Not for use in a handheld router!

SPECIFICATIONS

Manufacturer	Amana Tool
Diameter	3 3/8 in
B1	3/8 in
Cut Depth	1 7/16 in
Cut Height, Length, or Width	9/16 in
Flute	2
Overall Length	2 1/2 in
Radius	7/8 in
RPM	12,000
Shank	1/2 in