

Edge of Arlington Saw & Tool, Inc.

124 South Collins
Arlington, TX 76010
Phone: 817-461-7171 • Fax: 817-795-6651
Toll Free: 888-461-7171
Email: info@eoasaw.com
Website: www.eoasaw.com

Application: Peripheral Milling & Face Milling

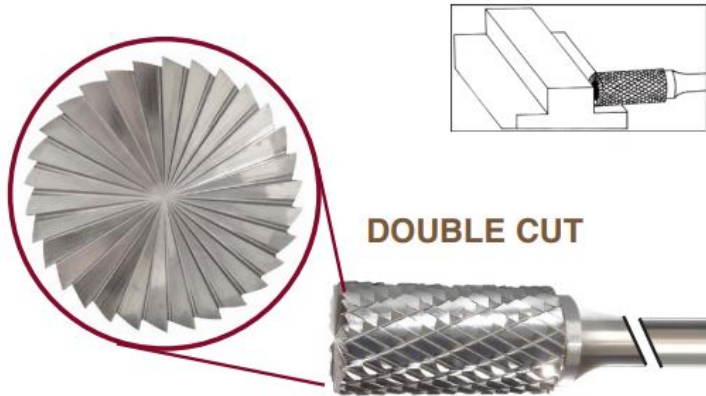

Item #17519, Viking Drill & Tool SB Cylinder Shape With End Cut - Double Cut: Peripheral Milling & Face Milling
\$20.74

Thank you for shopping with us!

Application: Peripheral Milling & Face Milling



SPECIFICATIONS

Manufacturer	Viking Drill & Tool
Diameter	3/8 in Cut Dia
Cut Height, Length, or Width	3/4 in Cut Length
Shank	1/4 in
Size	SB-3
Type	Cylinder Shape, With End Cut, Double Cut