

## Edge of Arlington Saw & Tool, Inc.

124 South Collins  
Arlington, TX 76010  
Phone: 817-461-7171 • Fax: 817-795-6651  
Toll Free: 888-461-7171  
Email: [info@eoasaw.com](mailto:info@eoasaw.com)  
Website: [www.eoasaw.com](http://www.eoasaw.com)

### Application: Peripheral Milling & Face Milling

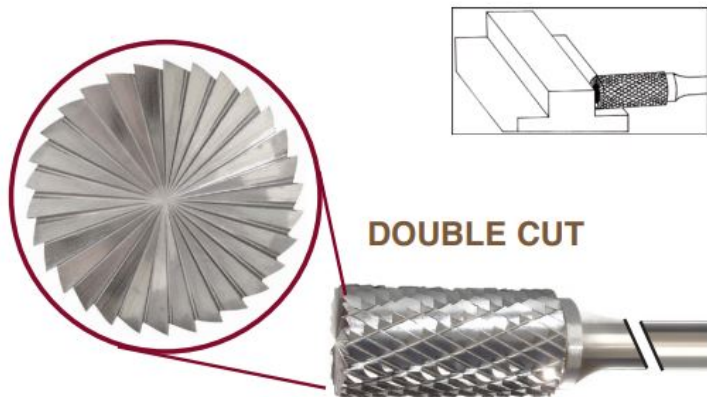

**Item #17409, Viking Drill & Tool SB Cylinder Shape With End Cut - Double Cut: Peripheral Milling & Face Milling**  
**\$8.27**

Thank you for shopping with us!

**Application:** Peripheral Milling & Face Milling



### SPECIFICATIONS

<b>Manufacturer</b>	Viking Drill & Tool
<b>Diameter</b>	1/16 in Cut Dia
<b>Cut Height, Length, or Width</b>	1/4 in Cut Length
<b>Shank</b>	1/8 in
<b>Size</b>	SB-41
<b>Type</b>	Cylinder Shape, With End Cut, Double Cut